

SEE DETAILS 3 & 4 FOR ANCHORING OPTIONS

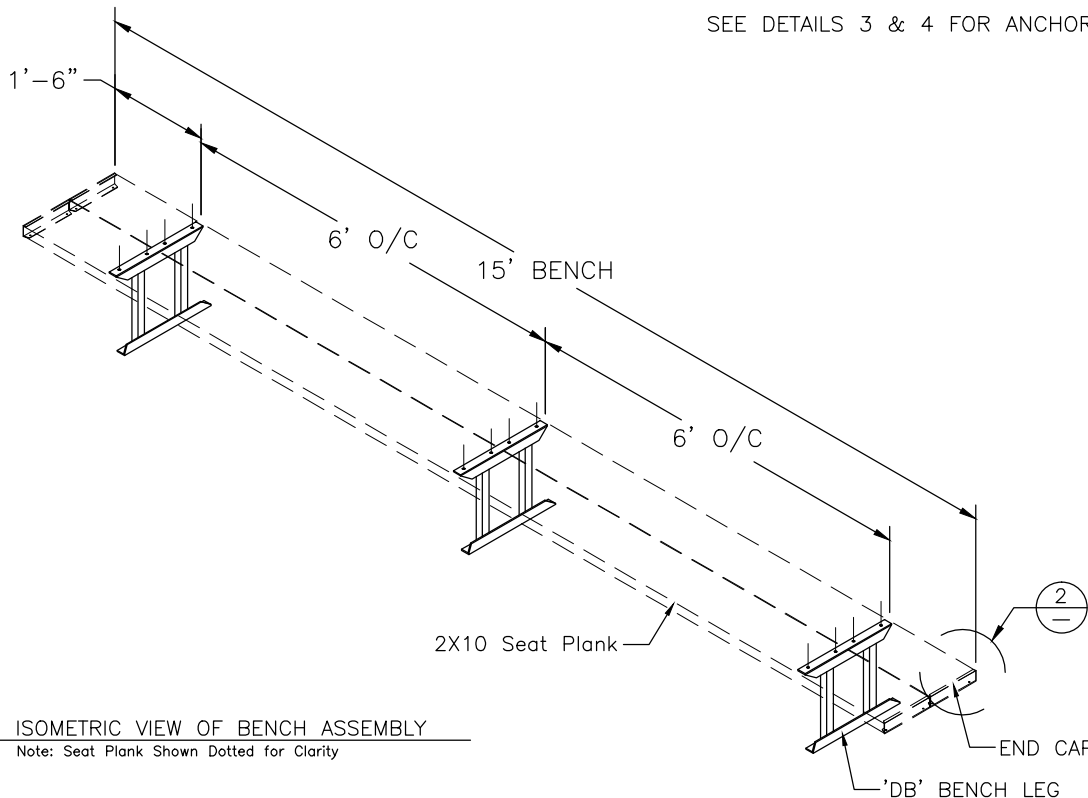

ISOMETRIC VIEW OF BENCH ASSEMBLY

Note: Seat Plank Shown Dotted for Clarity

③ TYP 2x10 PLANK ATTACHMENT

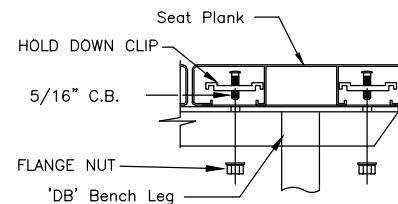

NOT TO SCALE

③ TYP 2x10 ENDCAP ATTACHMENT

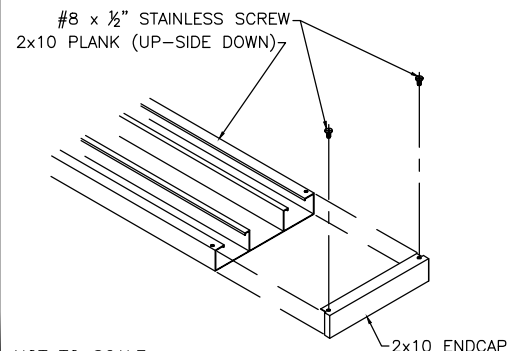

NOT TO SCALE

④ TYP ANCHORING DETAIL

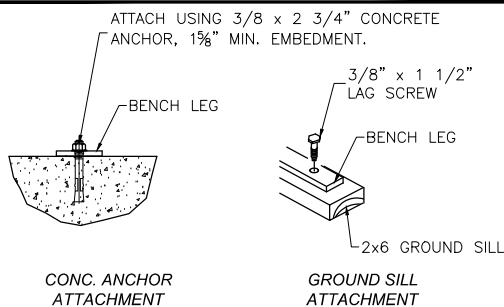

NOT TO SCALE

④ RUBBER FOOT PAD ATTACH. DETAIL

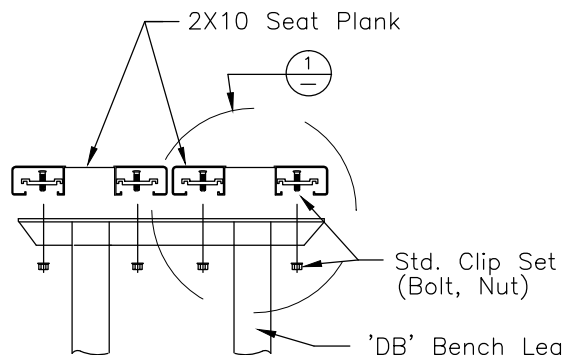
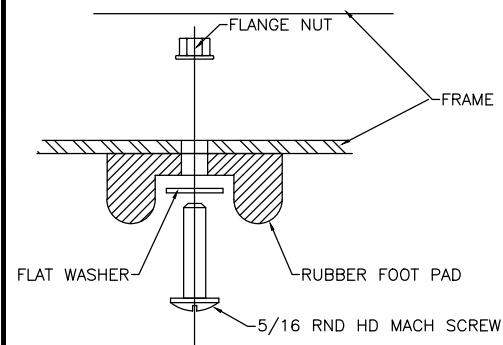

SIDE VIEW OF BENCH ASSEMBLY

This drawing and all information contained herein is the property of NATIONAL RECREATION SYSTEMS, INC. and is not to be reproduced without express written permission of this manufacturer. We assume no responsibility for unauthorized use of this drawing. National Recreation Systems, Inc. is not responsible for local permits and occupancy requirements.

National Recreation Systems, Inc.

P.O. BOX 11487 FORT WAYNE, IN 46858-1487

SCALE: NTS	APPROVED BY:	DRAWN BY: JLB
DATE: 10/30/12		
TITLE: 'DB' PORTABLE BENCH W/O BACK, 15'-0" LONG		
CUSTOMER:		DRAWING NUMBER: BDB01500