

BENCH ASSEMBLY

NOTE: SEAT PLANK SHOWN
DOTTED FOR CLARITY

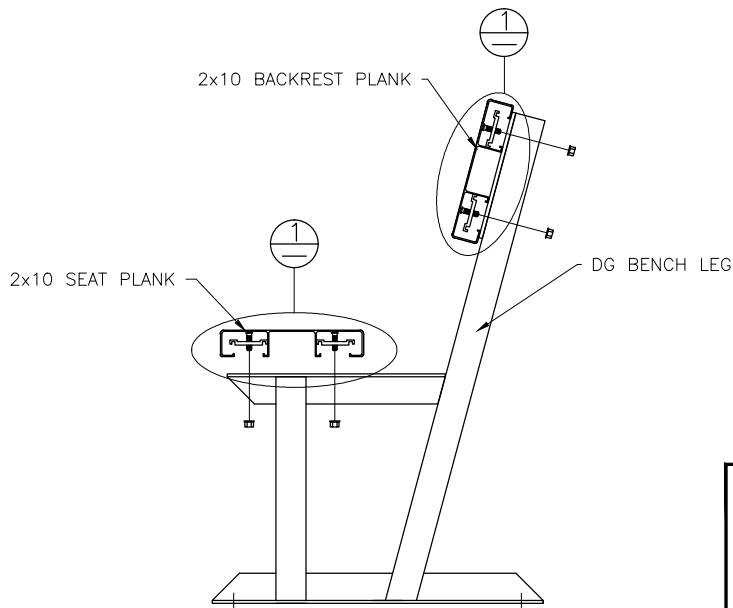
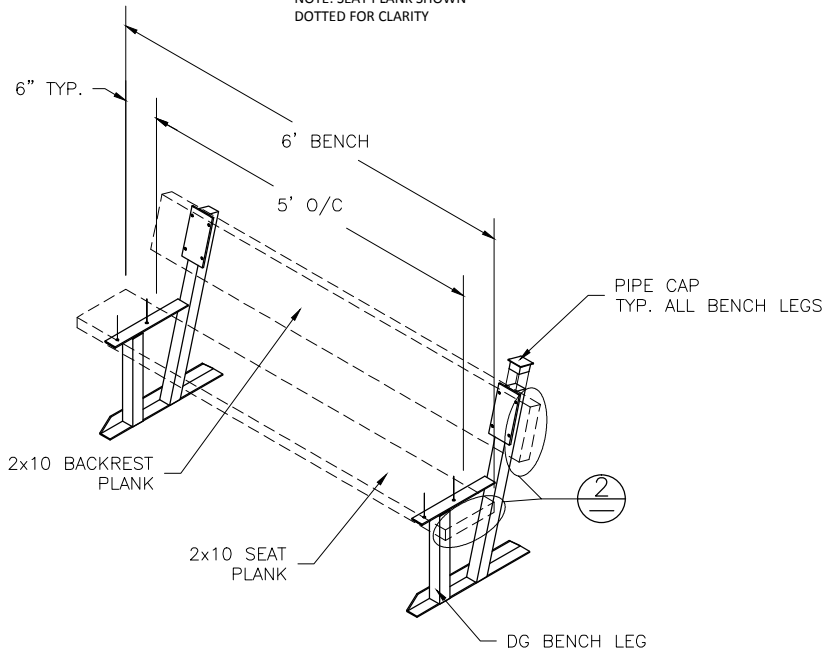

SEE DETAILS 3 & 4 FOR ANCHORING OPTIONS

③ TYP 2x10 PLANK ATTACHMENT

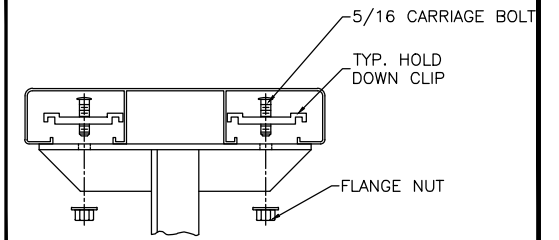

NOT TO SCALE

③ TYP 2x10 ENDCAP ATTACHMENT

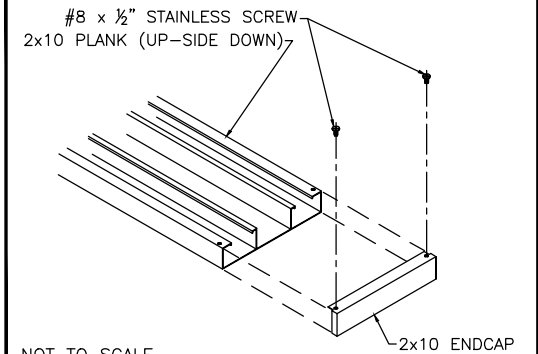

NOT TO SCALE

④ TYP ANCHORING DETAIL

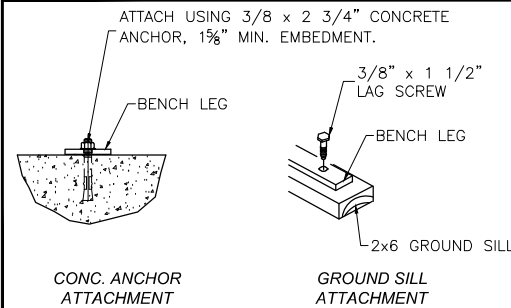

NOT TO SCALE

③ RUBBER FOOT PAD ATTACH. DETAIL

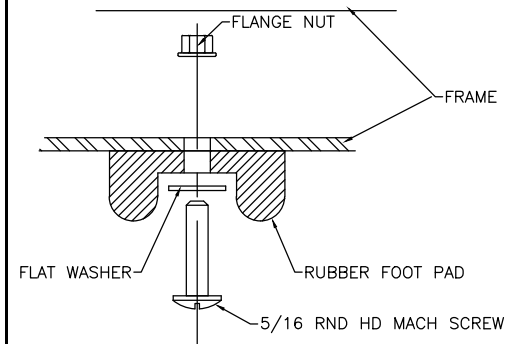

National Recreation Systems, Inc.

P.O. BOX 11487 FORT WAYNE, IN 46858-1487

SCALE: N.T.S.	APPROVED BY:	DRAWN BY: IMP
DATE: 6/20/12		
TITLE: DG PORTABLE BENCH W/BACK, 6'-0" LONG		
CUSTOMER:		DRAWING NUMBER: BDG00600

This drawing and all information contained herein is the property of NATIONAL RECREATION SYSTEMS, INC. and is not to be reproduced without express written permission of this manufacturer. We assume no responsibility for unauthorized use of this drawing. National Recreation Systems, Inc. is not responsible for local permits and occupancy requirements.