

**ISOMETRIC VIEW OF BENCH ASSEMBLY**

Note: Plank Shown Dotted for Clarity

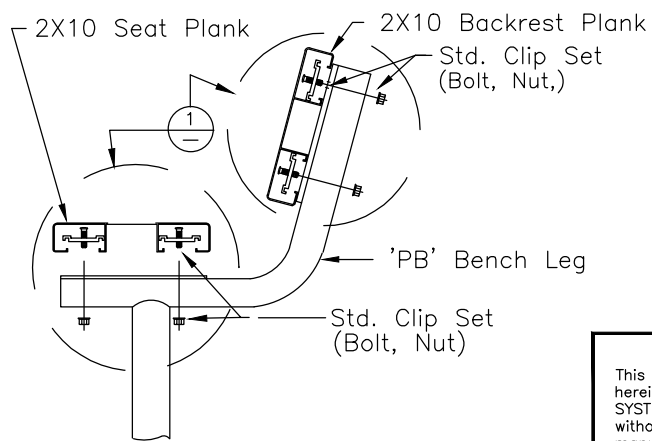

**SIDE VIEW OF BENCH ASSEMBLY**

**1 TYP 2x10 PLANK ATTACHMENT**

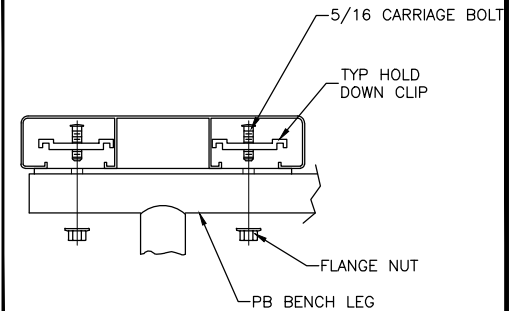

NOT TO SCALE

**2 TYP 2x10 ENDCAP ATTACHMENT**

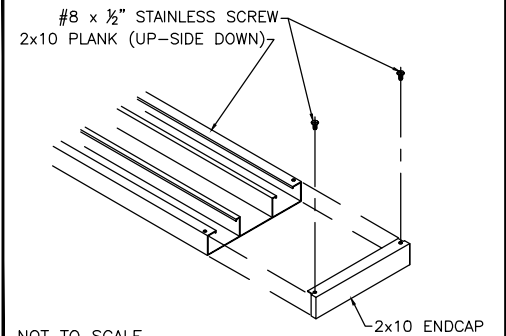

NOT TO SCALE

**3 PERMANENT BENCH HEIGHT DETAIL**

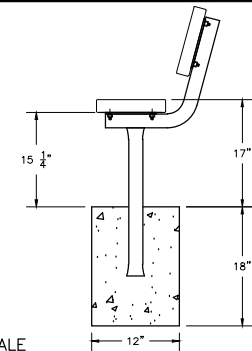

NOT TO SCALE

This drawing and all information contained herein is the property of NATIONAL RECREATION SYSTEMS, INC. and is not to be reproduced without express written permission of this manufacturer. We assume no responsibility for unauthorized use of this drawing. National Recreation Systems, Inc. is not responsible for local permits and occupancy requirements.

**National Recreation Systems, Inc.**

P.O. BOX 11487 FORT WAYNE, IN 46858-1487

SCALE: N.T.S.	APPROVED BY:	DRAWN BY: IMP
DATE: 11/12/12		
TITLE: 'PB' PERMANENT BENCH W/BACK, 12'-0" LONG		
CUSTOMER:		DRAWING NUMBER: BPB01200